



GST200N Series Intelligent Fire Alarm Control Panel



Description

GST200N Intelligent Fire Alarm Control Panels are designed in comply with EN54-2 and EN54-4 standard (LPCB certificate No.: 548p) with qualities of simple installation, operation, and easy maintenance. 1-2 loop addressable panel is suitable for small buildings like office, restaurant, store, shop, etc.

Installation Data

GST200N panel is wall-mount/flush-mount combined. Its appearance and the mounting holes are shown here.

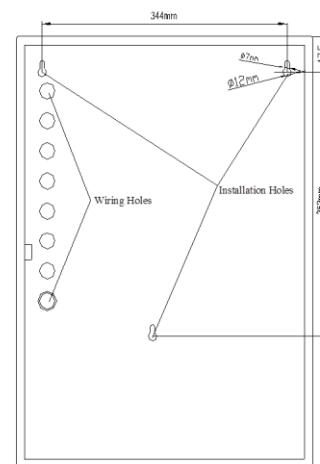
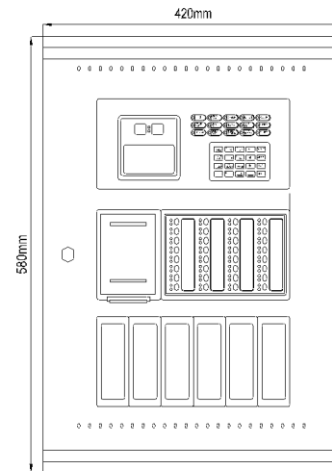

Features and Benefits

- Max. 30 zones. Each zone has its own alarm and fault/disable indicator and a label
- Single loop panel capacity 235 addressable devices
- 2-loop panel capacity 477 addressable devices
- Compatible with GST intelligent and digital products
- 8X18 characters LCD screen
- 15 LEDs to display important information
- Non-Volatile memory ensures no loss of data even if power supply is accidentally removed
- Wide range power supply
- Sounder strobe output provides 0.5A/24V load, compatible with GST conventional sounders
- RS232 interface enables communication with PC
- RS485 or CAN interface enables networking

Terminals

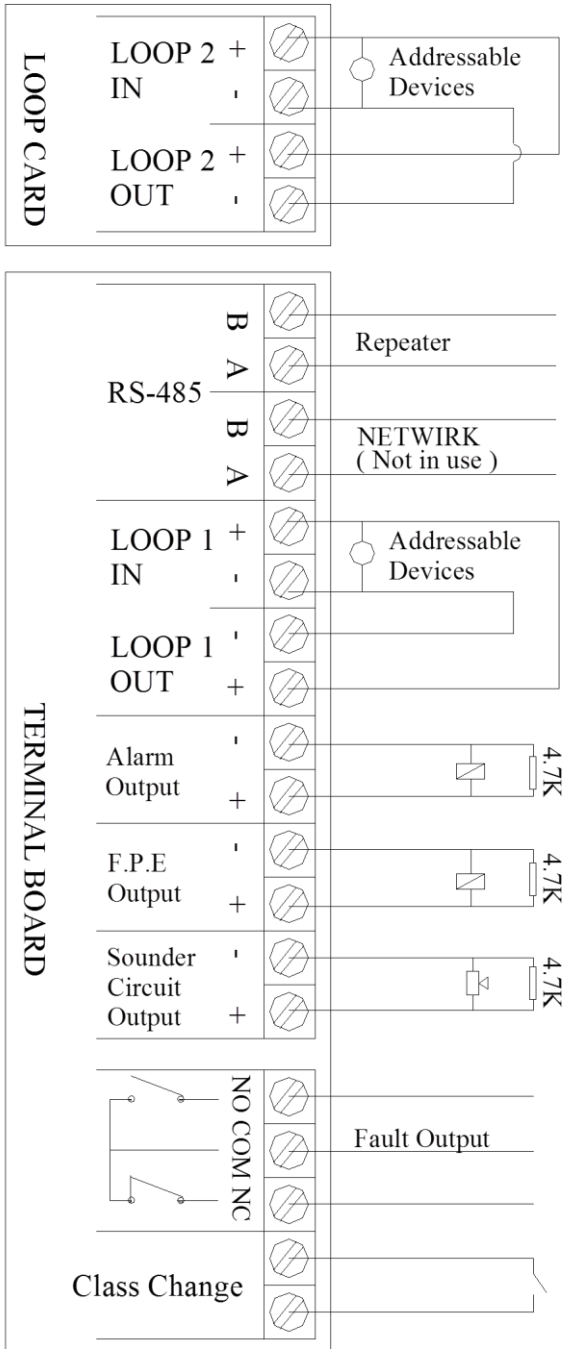

Loop(s):

The 2-loop panel adapts an additional loop card. Class A type connection should be applied, from Loop Out to Loop IN. Beware of the polarization.

Network:

A network card will be used for connecting into GST network. Beware of the polarization.

Active outputs:

3 active outputs are provided for general alarm (500mA), sounder circuit (500mA) and fire protection equipment (500mA), at 24VDC with cable monitoring. A 4k7 EOLR is required. Each can be set NO, NC or Active.

Repeater output:

Linked with the main board, individual line from network

Fault output:

A general fault output is provided with both NO and NC contact. The relay will be engaged when panel is in normal status, and discharged whenever any fault occurs or powered off.

Class Change:

Remote control of Sounder Circuit output

Cable Requirement

* All cables should be fire rated and follow local codes.

Loop: Min. 1.0mm², ideally 1.5mm², 1500 meters

Network: Min. 1.0mm², ideally 1.5mm², 1200 meters

Active Outputs: Min. 1.5mm², ideally 2.5mm²

Certificates and Compliance

- Standards: CE / CPD / EN54-2 / EN54-4
- Certifications: LPCB
- BS5839-1 Compliant
- WEEE & RoHS Compliant

Technical Specification

Primary Supply	100-240VAC, 50/60Hz
AC Current	1.5A
Standby Power	21AH/24VDC
Max. Battery Resistance	1 Ω
Loop Capacity	1 or 2 Loops
Zone Capacity	30
Device Capacity	235 for 1 st loop 242 for 2 nd loop
Printer	Optional Thermal ASCII code printer
Display	8(lines) x 18 (characters), LCD
Network(RS485)	Class A, Max. 32 panels (by card)
Network(CAN)	Class A, Max. 100 panels (by card) Class B, Max. 240 panels (by card and other accessories)
PC Port	RS232/USB interface (by card)
Protection	IP30
Operating Environment	0 °C ~ +40 °C ≤95%, non-condensing
Dimensions	420mm(W) x 580mm(H) x 202mm(D)

Order Information & Variant Models

Part No.	GST200N
Device Name	Intelligent Fire Alarm Control Panel

Part No.	Order Code	Property
GST200N-1	1005118	Single loop version
GST200N-2	1004784	2-loop version
GST200N-FR	1005123	French Model, 1-loop
GST200N-HU	1005121	Hungarian Model, 1-loop
GST200N-IT	1005122	Italian Model, 1-loop
GST200N-PT	1005119	Portuguese Model, 1-loop
GST200N-SP	1005120	Spanish Model, 1-loop
GST200N-TK	1005124	Turkish Model, 1-loop
GST200N-RO	1005517	Romanian Model, 1-loop

Compatible Devices







Networks:

GST-IFP8 Intelligent Fire Alarm Control Panel
 GST200N Series Intelligent Fire Alarm Panel
 GST200-2 Series Intelligent Fire Alarm Panel
 GSTGMC Graphic Monitor Software
 GST-NRP00 Network Repeater Panel
 GST852RP LCD Passive Repeater Panel
 GST8903 Mimic Panel

Loop Devices:

DI-910xE Series Digital Intelligent Detector
 I-910x Series Intelligent Analogue Detector
 DI-9204E Addressable Manual Call Point
 I-930x Series Addressable Interfaces
 I-940x Series Addressable Sounders and Strobes
 C-950xE Series Line Isolators
 DC-9504E Base Mount Isolator
 I-960x Series Intelligent Combustible Gas Detectors

Accessories

	Part No.: LC200 Device name: Loop Card Order Code: 3631370
	Part No.: P-9930 Device name: RS232 Communication Card Order Code: 3671836
	Part No.: P-9940A Device name: RS485 Class A Network Card Order Code: 3660994
	Part No.: P-9960 Device name: CAN Class B Network Card Order Code: 3661849
	Part No.: P-9960A Device name: CAN Class A Network Card Order Code: 3662002
	Part No.: P-9930ModBus Device name: ModBus Communication Card Order Code: 3671830
	Part No.: P-9930TCPIP Device name: TCP/IP interface card Order Code: 3672319