

GV-FER12203 12MP H.264 Low Lux Fisheye Rugged IP Camera



Introduction

GV-FER12203 is a 12 MP outdoor fisheye camera allowing you to monitor all angles of a location and can be installed to the ceiling and the wall. Equipped with automatic IR-cut filter and IR LEDs, GV-FER12203 is capable of day and night surveillance. Without installing any software, you can watch live view and utilize functions such as motion detection, privacy mask and alert notification through its Web interface. In addition, the camera seamlessly integrates with GV-DVR / NVR / VMS, providing advanced monitoring and video management features.

Key Features

- 1/1.7" progressive scan CMOS
- Dual streams from H.264 and MJPEG
- Up to 15 fps at 4000 x 3000
- Day and night (with removable IR-cut filter)
- Intelligent IR
- Vandal resistance (IK10+ for metal casing)
- Ingress protection (IP67)
- 12V DC / 24V AC / PoE+ (IEEE 802.3at)
- Built-in micro SD card slot (SD/SDHC/SDXC/UHS-I) for local storage
- One sensor input and alarm output
- Built-in microphone
- [Digital Object Tracking](#)
- Provides 360° and 180° panorama view
- Different angle of view accessible by multiple users at the same time
- Playback from any view angle and zoom level
- No mechanical moving parts
- Two-way audio
- Low lux enhancement
- 3D noise reduction
- Smart streaming
- Tampering alarm
- Virtual PTZ function
- Auto Pan function
- Privacy mask
- Visual automation
- Text overlay
- 31 languages on Web interface
- ONVIF (Profile S) conformant
- Recording assigned by GV-Edge Recording Manager ([Windows version](#))

* No Memory Card Slot & local storage function for Argentina.

* Smart streaming requires either GV-NVR V8.7.0.0 or GV-VMS V16.10.0.0.

The following is a comparison of live view between a third-party fisheye camera and a GV-Fisheye Camera with IR LED.

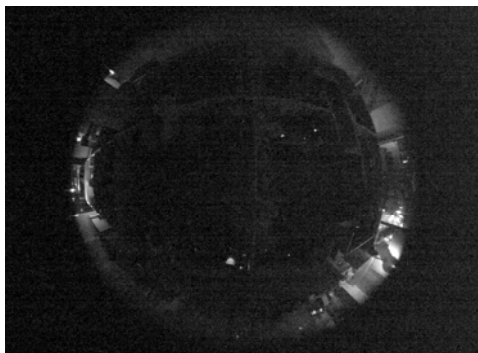

Third-Party Fisheye Camera

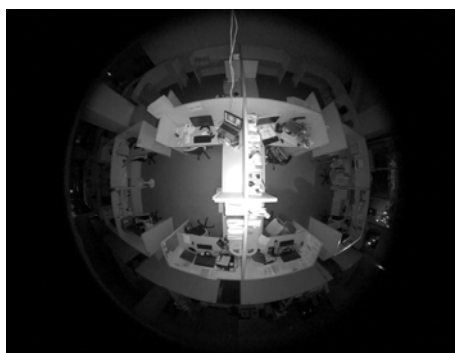

GV-Fisheye Camera with IR LED

Photos

Fisheye Source Image



Single View



2 x 180° View



360° View



Quad View

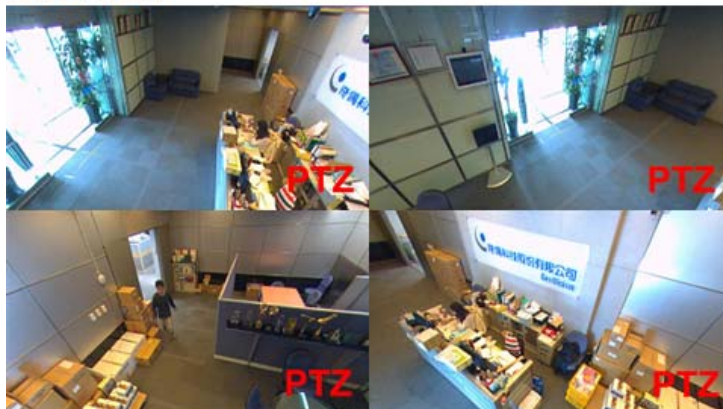

Dimensions

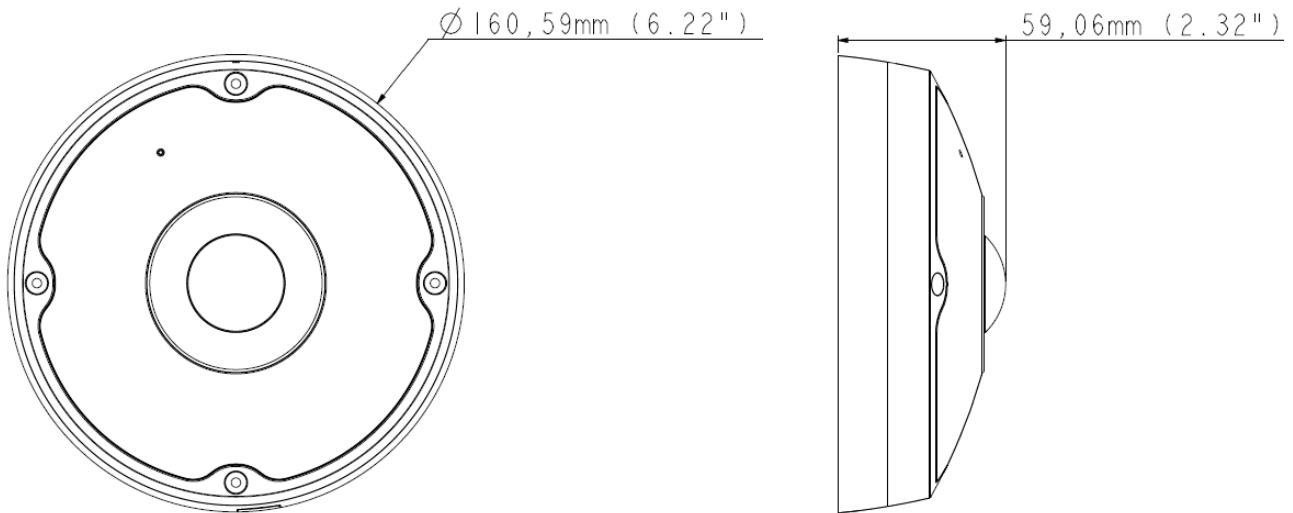

Specifications

System Requirements		
CPU	Intel Core i5-4670, 3.40 GHz	
Memory	DDR3 8 GB RAM	
On Board Graphics	Intel HD Graphics 4600 (Versions of driver from year 2014 or later required)	
Camera		
Image Sensor	1/1.7" progressive scan CMOS	
Picture Elements	4000 (H) x 3000 (V)	
Minimum Illumination	Color	0.1 Lux
	B/W	0.05 Lux
	IR On	0 Lux
Shutter Speed	Automatic, Manual (1/30 ~ 1/16000 sec)	
White Balance	Automatic, Manual (2800K ~ 8500K)	
Gain Control	Automatic	
S/N Ratio	52 dB	
Optics Lens		
Megapixel	Yes	
Day/Night	Yes (with removable IR-cut filter)	
Lens Type	Fixed	
Focal Length	1.83 mm	
Maximum Aperture	F/2.4	
Mount	M12	
Image Format	1/1.7"	
Horizontal FOV	180°	
Operation	Focus	Fixed
	Zoom	Fixed
	Iris	Fixed
IR LED Quantity	6 IR LEDs	
Max. IR Distance	30 m (98.43 ft)	
Operation		
Video Compression	H.264, MJPEG	
Video Streaming	Dual streams from H.264 or MJPEG	
Frame Rate	15 fps at 4000 x 3000, 25 fps at 2896 x 2768 (60/50 Hz) *The frame rate and the performance may vary depending on the number of connections and data bitrates (different scenes).	

Image Setting	Brightness, Contrast, Saturation, Sharpness, Gamma, White Balance, Flicker-less, Image Orientation, Shutter Speed, D/N, Denoise, Low Lux Enhancement, Metering	
Audio Compression	G.711	
Audio Support	Two-way Audio (external speaker required)	
Sensor Input	1 input (Dry Contact)	
Sensor Output	1 Digital Output (200mA 5V DC)	
Video Resolution		
Main Stream	4:3	4000 x 3000 (Default)
	20:19	2896 x 2768
Sub Stream	4:3	640 x 480 (Default)
	20:19	640 x 608
Network		
Interface	10/100/1000 Ethernet	
Protocol	DHCP, DNS, DynDNS, FTP, HTTP, HTTPS, ICMP, IPv4, NTP, ONVIF (Profile S), QoS (DSCP), RTCP, RTSP, SNMP, SMTP, SSL, TCP/IP, UDP, UPnP, 3GPP/ISMA	
Wireless LAN	IEEE 802.11 b/g/n (not functional)	
Antenna Type	External	
Security	WEP, WPA-PSK(TKIP), WPA-PSK(AES), WPA2-PSK(TKIP), WPA2-PSK(AES)	
Mechanical		
Temperature Detector	Yes	
Connectors	Power	2-pin terminal block (DC 12V, 3.5A), PoE
	Ethernet	RJ-45
	Audio	1 In (Built-in or external microphone) 1 Out (Stereo phone jack, 3.5 mm / 0.14")
	Digital I/O	3-pin terminal block, pitch 2.5 mm (0.1")
	Auto Iris	None
	Local Storage	Micro SD card slot (SDHC/SDXC/UHS-I, Class 10) * UHS-II card type is not supported.
	USB	USB hard drive
General		
Operating Temperature	-40°C ~ 50°C (-40°F ~ 122°F)	
Humidity	10% to 90% (no condensation)	
Power Source	12V DC / 24V AC / PoE+ (IEEE 802.3at)	
Max. Power Consumption	28 W	
Dimension	∅ 160.59 x 59.06 mm m (∅ 6.22" x 2.32")	
Weight	700 g (1.54 lb)	
Ingress Protection	IP67	
Vandal Resistance	IK10+ for metal casing	
Regulatory	CE, FCC, RCM, LVD, RoHS compliant	
Power over Ethernet		
PoE Standard	PoE+ (IEEE 802.3at Power over Ethernet / PD)	
PoE Power Supply Type	End-Span	
PoE Power Output	Per Port 48V DC, 600mA. Max. 30 watts	
Web Interface		
Installation Management	Web-based configuration	
Maintenance	Firmware upgrade through Web Browser or Utility	
Access from Web Browser	Camera Live View, Video Recording, Change Video Quality, Bandwidth Control, Image Snapshot, Digital I/O Control, Audio, Picture in Picture, Picture and Picture, Motion Detection, Privacy Mask, Visual Automation, Tampering Alarm, Auto Pan Function, Virtual PTZ, Wide Angle Lens Dewarping, Text Overlay	
Language	Arabic / Bulgarian / Czech / Danish / Dutch / English / Finnish / French / German / Greek / Hebrew / Hungarian / Indonesian / Italian / Japanese / Lithuanian / Norwegian / Persian / Polish / Portuguese / Romanian / Russian / Serbian / Simplified Chinese / Slovakian / Slovenian / Spanish / Swedish / Thai / Traditional Chinese / Turkish	

Applications

Network Storage	GV-VMS / DVR / NVR, GV-Backup Center, GV-Recording Server
Live Viewing	IE, Mobile App
CMS Server Support	GV-Control Center, GV-Center V2, GV-Vital Sign Monitor

Note:

- Do not use clothes or any ordinary material to clean the camera cover since they may result in scratches.
- Mind the following when using an inserted memory card for recording:
 - Recorded data on the memory card can be damaged or lost if the data are accessed while the camera is under physical shock, power interruption, memory card detachment or when the memory card reaches the end of its lifespan. No guarantee is provided for such causes.
 - The stored data can be lost if the memory card is not accessed for a long period of time. Back up your data periodically if you seldom access the memory card.
 - Memory cards are expendable and their durability varies according to the conditions of the installed site and how they are used. Back up your data regularly and replace the memory card annually.
 - To avoid power outage, it is highly suggested to apply a battery backup (UPS).
 - For better performance, it is highly suggested to use Micro SD card of MLC NAND flash, Class 10.
 - Replace the memory card when its read/write speed is lower than 6 MB/s or when the memory card is frequently undetected by the camera.
- Specifications are subject to change without notice.

Packing List



- | | |
|-----------------------------|-------------------------|
| 1. Fisheye Camera | 8. Terminal Block |
| 2. Back Plate | 9. Installation Sticker |
| 3. Plate Screw x 3 | 10. Ruler |
| 4. Plastic Screw Anchor x 3 | 11. Silica Gel Bag x 2 |
| 5. Torx Wrench | 12. Power Adapter |
| 6. RJ-45 Connector | 13. Download Guide |
| 7. Data Cable | 14. Warranty Card |

Note: The power adapter can be excluded upon request.

Accessories

Model No.	Name		Details
GV-Mount100	Straight Tube and Junction Box Kit		Dimensions: 200 x 170 x 257.5 mm (7.9" x 6.7" x 10.1") Weight: 3.17 kg (6.99 lb)
GV-Mount101	Straight Tube Kit		Dimensions: 219 x 125 x 332 mm (8.6" x 4.9" x 13.1") Weight: 1.8 kg (3.97 lb)

Model No.	Name		Details
GV-Mount200	Wall Pendant Mount		<p>Dimensions: 225 x 140 x 250 mm (8.9" x 5.5" x 9.8")</p> <p>Weight: 900 g (1.98 lb)</p> <p>Note: To ensure the image quality, leave a distance of 1 M or more between the camera body and the wall.</p>
GV-Mount203	Wall Mount and Junction Box		<p>Dimensions: 315 x 195.5 x 225 mm (12.4" x 7.7" x 8.9")</p> <p>Weight: 2.95 kg (6.5 lb)</p> <p>Note: To ensure the image quality, leave a distance of 1 M or more between the camera body and the wall.</p>
GV-Mount206	Wall Box Mount		<p>Dimensions: 126.5 x 211.3 x \varnothing 176.85 mm (5" x 8.3" x \varnothing 6.96")</p> <p>Weight: 0.93 kg / 2.06 lb</p> <p>Note: To ensure the image quality, leave a distance of 1 M or more between the camera body and the wall.</p>
GV-Mount 208-2	Swan Neck Mount		<p>Dimensions: 1043 x 519 x 256 mm (41.06" x 20.43" x 10.08")</p> <p>Weight 10.5 kg (23.15 lb)</p>
GV-Mount702	Extension Tube		<p>Four options are available.</p> <p>Dimensions: \varnothing 5.4 x 10 or 20 or 30 or 50 cm (\varnothing 2.1" x 3.9" or 7.9" or 11.8" or 19.7")</p> <p>Weight: 180 g or 390 g or 550 g or 800 g (0.4 lb or 0.86 lb or 1.21 lb or 1.76 lb)</p>

Model No.	Name	Details
GV-Mount903-1	Dome Housing	 <p>Dimensions: \varnothing 185.51 x 165.35 mm (\varnothing 7.3" x 6.51") Weight: 900 g (1.98 lb)</p>
GV-Mount904-1	Tilting Wall Mount Bracket	 <p>Dimensions: \varnothing 159.1 x 40.5 mm (\varnothing 6.3" x 1.6") Weight: 350 g (0.77 lb)</p>
GV-Mount912	Power Box Mount Bracket	 <p>Dimensions: \varnothing 146 x 10.5 mm (\varnothing 5.7" x 0.4") Weight: 180 g (0.4 lb)</p>
GV-Relay V2		GV-Relay V2 is designed to expand the voltage load of GV IP devices. It provides 4 relay outputs, and each can be set as normally open (NO) or normally closed (NC) independently as per your requirement.
GV-POE Switch		GV-POE Switch is designed to provide power along with network connection for IP devices. The GV-POE Switch is available in various models with different numbers and types of ports.
Power Adapter		Contact our sales representatives for the countries and areas supported.